



LUXHOME

SEATING



2024

TABLE OF CONTENTS

Ellington 1100 Collection	4
Ellington RAF Corner Sofa, Armless Loveseat & LAF Chaise Panel Arm	5
Ellington Sofa Panel Arm	6
Ellington Chair Panel Arm	6
Ellington 26" Footstool	7
Ellington 1100 Available Pieces	8
Ellington 1100 Sectional Examples	9
Ellington 1200 Collection	10
Ellington Sofa Sock Arm	11
Ellington Loveseat Sock Arm	12
Ellington Chair Sock Arm	12
Ellington 26" Footstool	13
Ellington 1200 Available Pieces	14
Ellington 1200 Sectional Examples	15
Harmony Collection	16
Harmony WH 6-Piece Sectional	17
Harmony WH 5-Piece Sectional	18
Harmony WH Sofa Recliner	19
Harmony WH Loveseat Recliner	20
Harmony WH Recliner w/Power Option	21
Harmony Push Back Recliner	22
Harmony Rocker Recliner	23
Harmony Swivel Glider Recliner	24
Harmony Swivel Rocker Recliner	25
Serene Collection	26
Fully Modular, Q&A & Reversible Cushions	27
Serene 5-Seat Sectional Flat Arm	28
Serene 5-Seat Sectional Tear Drop Arm	28
Serene Sofa Flat Arm	29
Serene Sofa Tear Drop Arm	29
Serene Loveseat Flat Arm	30
Serene Loveseat Tear Drop Arm	30
Serene Chair Flat Arm	31
Serene Chair Tear Drop Arm	31
Serene Footstool	32
Serene Chaise	33
Serene Extra Seat Unit	34
Serene Available Pieces & Sectional Examples	35
Brown Maple & Oak Stain Colors	36
Fabrics & Leathers	37
Care & Cleaning Guide	38
Warranty	39

FEEL THE DIFFERENCE

LuxHome Seating is a brand founded in 2023 by AJ's Furniture LLC with a focus on manufacturing fully upholstered living room seating with sleek cutting-edge designs for the wholesale market. Each item is built from scratch by our teams of skilled Amish craftsman and women. From hardwood frames with mortise and tenon joints, to drop-in coil spring seating, to high resilient foam covered with either a standard fabric, performance fabric or leather from the vast collection offered by Heartland Fabrics. Every piece is made for supreme comfort and longevity.

Please note: LuxHome works exclusively with Heartland Fabrics. The buyer is responsible for supplying LuxHome with any fabric or leather selected outside of Heartland Fabrics. Please see the price list for the yardage chart of all LuxHome products.

SINGLE CONE COILS SPRINGS – RIGID-BAR SPRING CONSTRUCTION (DROP-IN COIL SPRINGS)



The coil springs in the Rigid Bar Construction are connected by a link-top fabrication, which spreads the weight load per spring more evenly than an 8 Way Hand-Tied unit. An added feature to the Rigid Bar Coil Construction is what is referred to as a “Soft Edge” or a formed-up front. A “formed-up Soft Edge” unit gives greater support to the front of the unit, while helping to preserve the life of the cushion.

One size does not fit all. The size, height, diameter, wire gage, and spacing of these springs are custom made for each piece of furniture. The seating height, cushion depth, and upholstery material were all considered during this process. Every spring has been heat tempered (after forming) to insure a lifetime of consistent comfort. The springs in this fine furniture carry a lifetime warranty.

The spring unit and seat cushion form a marriage of comfort. The density of the foam, and the ride depth of the spring, combine to give a perfect seating experience. Our commitment to quality includes the unseen springs inside of this furniture. Though out of site, no expense was spared in order to deliver to you the most comfortable and consistent seating experience available today. Compare, and feel the LuxHome difference.



LUXHOME
SEATING

ELLINGTON 1100 COLLECTION



FEATURES

- Solid Hardwood Maple Frame with Mortise and Tenon Construction
- Drop-in Coil Spring System
- Semi-Attached Fiber Filled Backs with Zipper
- High Resilience 2.6 Density 30 Lb Seat Foam
- Removable Tapered Legs
- Soft Edge Seating

CUSTOM OPTIONS

- Softer 23 Lb Seat Foam (no upcharge)
- Firmer 40 Lb Seat Foam (no upcharge)
- Foam Insert for Backs (upcharge, see price list)

WOOD LEGS

- Available in Brown Maple or Oak
- See Page 36 for Stain Color Options

ELLINGTON RAF CORNER SOFA, ARMLESS LOVESEAT & LAF CHAISE PANEL ARM



Shown in 23-13 Whitesand Fabric and Brown Maple with FC 11047 Ebony

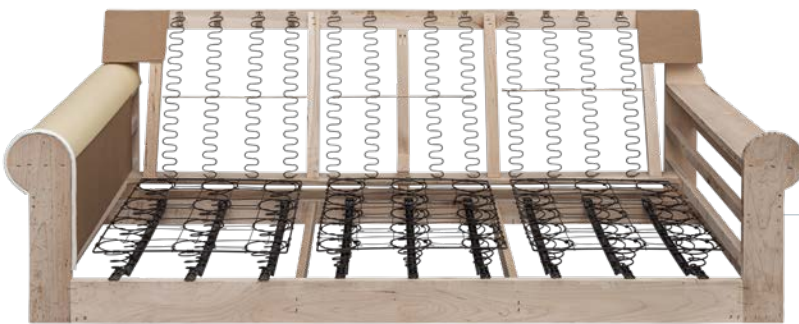

CONSTRUCTION

Ellington frames are made with solid hardwood maple and are constructed with mortise and tenon joints.

DIMENSIONS

	Length	Depth	Height	Inside Length	Seat Height	Seat Depth	Arm Height
1104 EL Ellington RAF Chair Panel Arm	31	38	38	22	19	21	25
1105 EL Ellington RAF Loveseat Panel Arm	53	38	38	44	19	21	25
1106 EL Ellington RAF Sofa Panel Arm	75	38	38	66	19	21	25
1107 EL Ellington LAF Chair Panel Arm	31	38	38	22	19	21	25
1108 EL Ellington LAF Loveseat Panel Arm	53	38	38	44	19	21	25
1109 EL Ellington LAF Sofa Panel Arm	75	38	38	66	19	21	25
1110 EL Ellington RAF Chaise Panel Arm	31	67	38	22	19	51	25
1111 EL Ellington LAF Chaise Panel Arm <i>(shown)</i>	31	67	38	22	19	51	25
1112 EL Ellington RAF Corner Sofa Panel Arm <i>(shown)</i>	91	38	38	65	19	21	25
1113 EL Ellington LAF Corner Sofa Panel Arm	91	38	38	65	19	21	25
1114-EL Ellington Corner Seat	38	38	38	22	19	21	-
1115-EL Ellington Armless Chair	22	38	38	22	19	21	-
1116-EL Ellington Armless Loveseat <i>(shown)</i>	44	38	38	44	19	21	-
1117-EL Ellington Armless Sofa	66	38	38	66	19	21	-

ELLINGTON SOFA PANEL ARM



Shown in 23-13 Whitesand Fabric and Brown Maple with FC 11047 Ebony

ELLINGTON CHAIR PANEL ARM



Shown in Texas Leather and Brown Maple with FC 11047 Ebony

DIMENSIONS

	Length	Depth	Height	Inside Length	Seat Height	Seat Depth	Arm Height
1103 EL Ellington Sofa Panel Arm	84	38	38	66	19	21	25
1102 EL Ellington Loveseat Panel Arm <i>(not shown)</i>	62	38	38	44	19	21	25
1101 EL Ellington Chair Panel Arm	40	38	38	22	19	21	25

ELLINGTON 26" FOOTSTOOL



Shown in Rum Leather (left) and Texas Leather (above/right) and Brown Maple with FC 11047 Ebony

DIMENSIONS

	Length	Depth	Height	Inside Length	Seat Height	Seat Depth	Arm Height
1126-EL Ellington 26" Footstool	26	24	16	-	-	-	-
1136-EL Ellington 36" Footstool <i>(not shown)</i>	36	24	16	-	-	-	-

ELLINGTON 1100 AVAILABLE PIECES

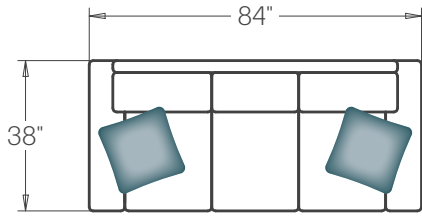

**Item #1103 EL
Sofa**

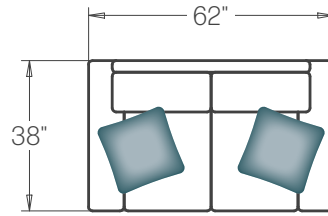

**Item #1102 EL
Loveseat**

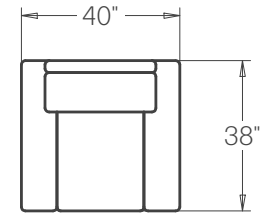

**Item #1101 EL
Chair**

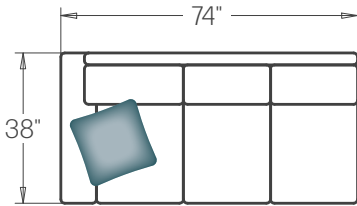

**Item #1109 EL
LAF Sofa**

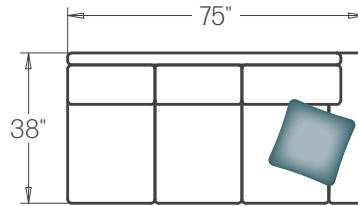

**Item #1106 EL
RAF Sofa**

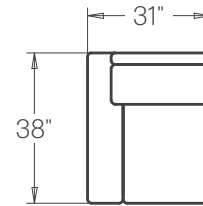

**Item #1107 EL
LAF Chair**

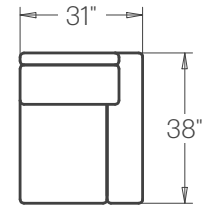

**Item #1104 EL
RAF Chair**

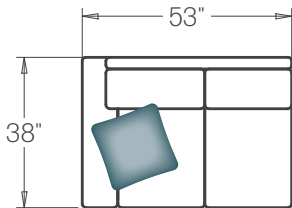

**Item #1108 EL
LAF Loveseat**

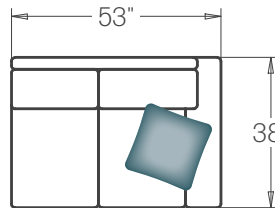

**Item #1105 EL
RAF Loveseat**

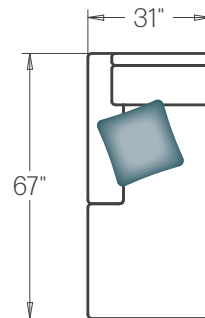

**Item #1111 EL
LAF Chaise**

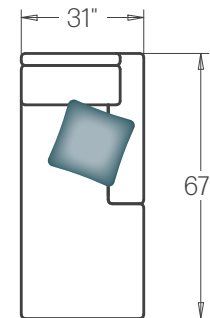

**Item #1110 EL
RAF Chaise**

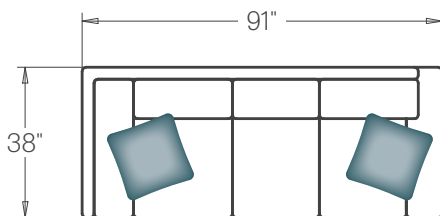

**Item #1112 EL
RAF Corner Sofa**

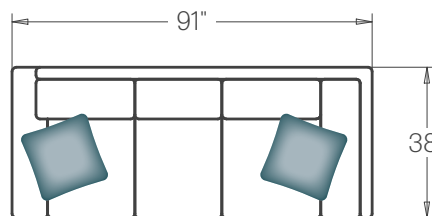

**Item #1113 EL
LAF Corner Sofa**

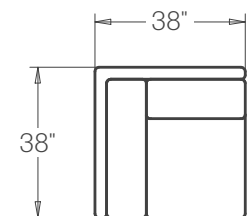

**Item #1114 EL
Corner Seat**

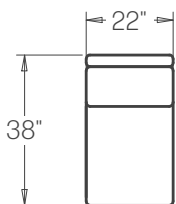

**Item #1115 EL
Armless Chair**

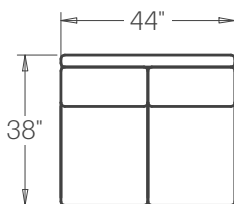

**Item #1116 EL
Armless Loveseat**

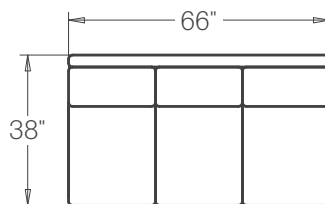

**Item #1117 EL
Armless Sofa**

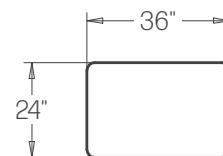

**Item #1136 EL
36" Footstool**

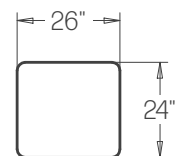

**Item #1126 EL
26" Footstool**

ELLINGTON 1100 SECTIONAL EXAMPLES

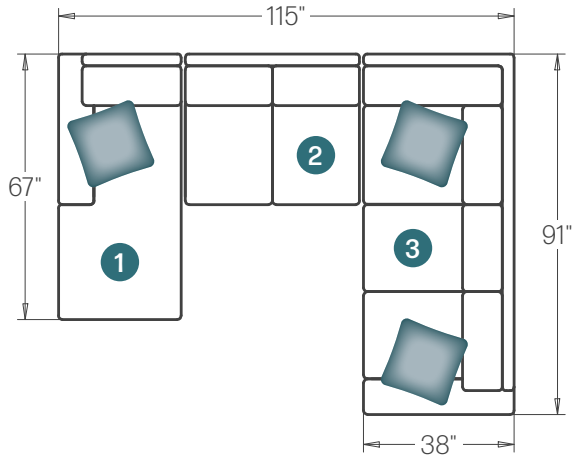

1 - Item #1111 EL LAF Chaise
 2 - Item #1116 EL Armless Loveseat
 3 - Item #1112 EL RAF Corner Sofa

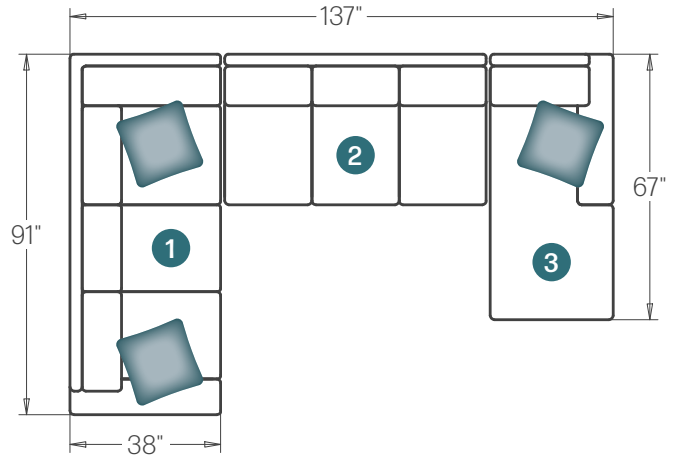

1 - Item #1113 EL LAF Corner Sofa
 2 - Item #1117 EL Armless Sofa
 3 - Item #1110 EL RAF Chaise

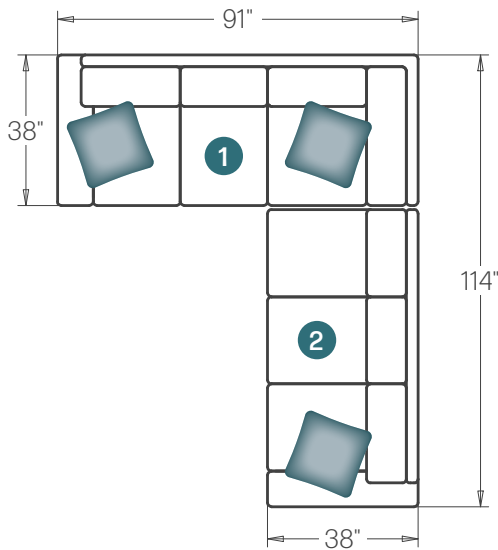

1 - Item #1113 EL LAF Corner Sofa
 2 - Item #1106 EL RAF Sofa

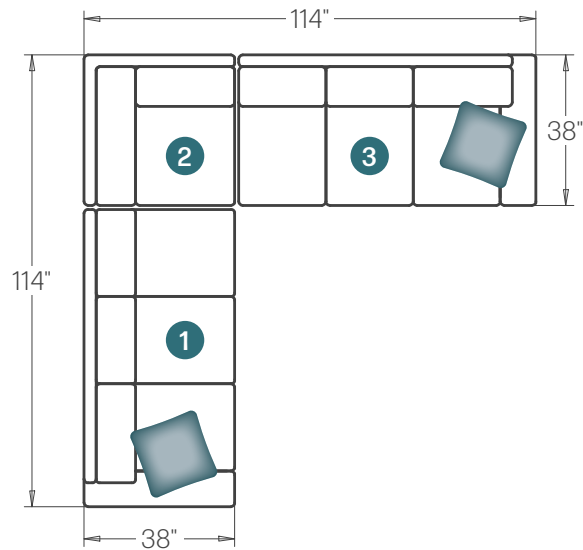

1 - Item #1109 EL LAF Sofa
 2 - Item #1114 EL Corner Seat
 3 - Item #1106 EL RAF Sofa

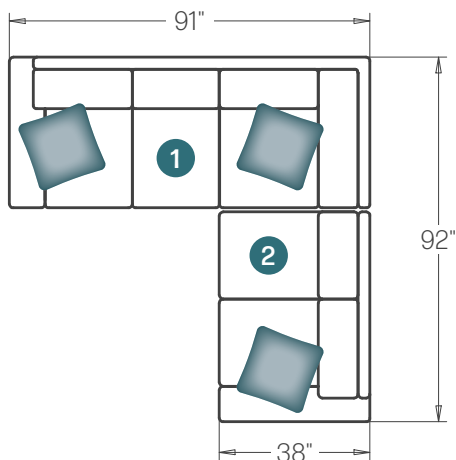

1 - Item #1113 EL LAF Corner Sofa
 2 - Item #1108 EL LAF Loveseat

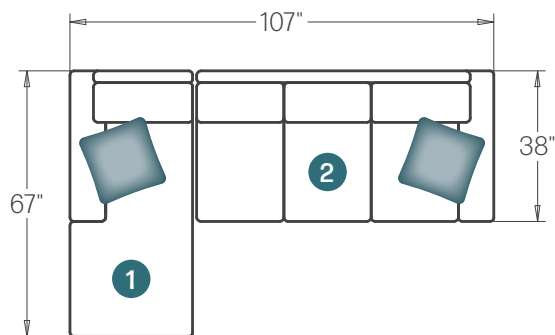

1 - Item #1111 EL LAF Chaise
 2 - Item #1106 EL RAF Sofa



LUXHOME
SEATING

ELLINGTON 1200 COLLECTION



FEATURES

- Solid Hardwood Maple Frame with Mortise and Tenon Construction
- Drop-in Coil Spring System
- Semi-Attached Fiber Filled Backs with Zipper
- High Resilience 2.6 Density 30 Lb Seat Foam
- Removable Tapered Legs
- Soft Edge Seating

CUSTOM OPTIONS

- Softer 23 Lb Seat Foam (no upcharge)
- Firmer 40 Lb Seat Foam (no upcharge)
- Foam Insert for Backs (upcharge, see price list)

WOOD LEGS

- Available in Brown Maple or Oak
- See Page 36 for Stain Color Options

Chair/26" Footstool Shown in Rum Leather, Sofa Shown in R1-19 Shack Fabric and Brown Maple with FC 11047 Ebony



ELLINGTON SOFA SOCK ARM



Shown in R1-19 Shack Fabric and Brown Maple with FC 11047 Ebony

DIMENSIONS

	Length	Depth	Height	Inside Length	Seat Height	Seat Depth	Arm Height
1203 EL Ellington Sofa Sock Arm <i>(shown)</i>	84	38	38	66	19	21	25
1204 EL Ellington RAF Chair Sock Arm	31	38	38	22	19	21	25
1205 EL Ellington RAF Loveseat Sock Arm	53	38	38	44	19	21	25
1206 EL Ellington RAF Sofa Sock Arm	75	38	38	66	19	21	25
1207 EL Ellington LAF Chair Sock Arm	31	38	38	22	19	21	25
1208 EL Ellington LAF Loveseat Sock Arm	53	38	38	44	19	21	25
1209 EL Ellington LAF Sofa Sock Arm	75	38	38	66	19	21	25
1210 EL Ellington RAF Chaise Sock Arm	31	67	38	22	19	51	25
1211 EL Ellington LAF Chaise Sock Arm	31	67	38	22	19	51	25
1212 EL Ellington RAF Corner Sofa Sock Arm	91	38	38	65	19	21	25
1213 EL Ellington LAF Corner Sofa Sock Arm	91	38	38	65	19	21	25
1214-EL Ellington Corner Seat	38	38	38	22	19	21	-
1215-EL Ellington Armless Chair	22	38	38	22	19	21	-
1216-EL Ellington Armless Loveseat	44	38	38	44	19	21	-
1217-EL Ellington Armless Sofa	66	38	38	66	19	21	-

ELLINGTON LOVESEAT SOCK ARM



Shown in R1-19 Shack Fabric and Brown Maple with FC 11047 Ebony

ELLINGTON CHAIR SOCK ARM



Shown in Rum Leather and Brown Maple with FC 11047 Ebony

DIMENSIONS

	Length	Depth	Height	Inside Length	Seat Height	Seat Depth	Arm Height
1202 EL Ellington Loveseat Sock Arm	62	38	38	44	19	21	25
1201 EL Ellington Chair Sock Arm	40	38	38	22	19	21	25

ELLINGTON 26" FOOTSTOOL



Shown in Rum Leather (left) and Texas Leather (above/right) and Brown Maple with FC 11047 Ebony

DIMENSIONS

	Length	Depth	Height	Inside Length	Seat Height	Seat Depth	Arm Height
1126-EL Ellington 26" Footstool	26	24	16	-	-	-	-
1136-EL Ellington 36" Footstool <i>(not shown)</i>	36	24	16	-	-	-	-

ELLINGTON 1200 AVAILABLE PIECES

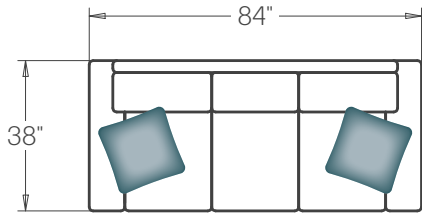

**Item #1203 EL
Sofa**

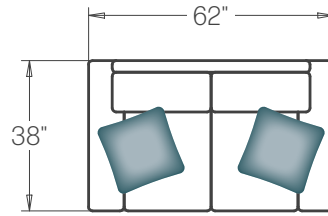

**Item #1202 EL
Loveseat**

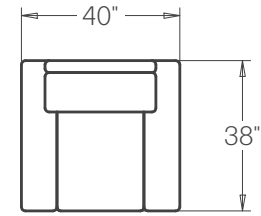

**Item #1201 EL
Chair**

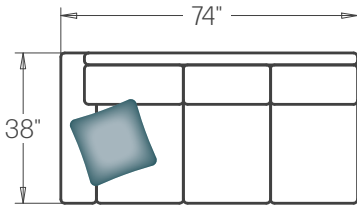

**Item #1209 EL
LAF Sofa**

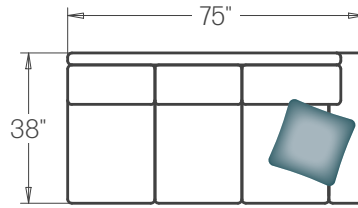

**Item #1206 EL
RAF Sofa**

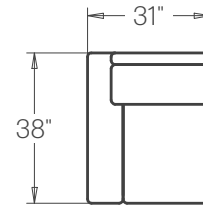

**Item #1207 EL
LAF Chair**

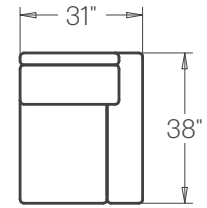

**Item #1204 EL
RAF Chair**

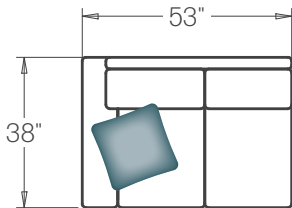

**Item #1208 EL
LAF Loveseat**

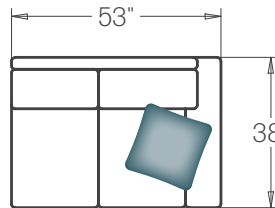

**Item #1205 EL
RAF Loveseat**

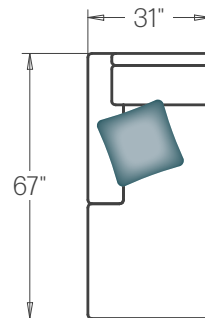

**Item #1211 EL
LAF Chaise**

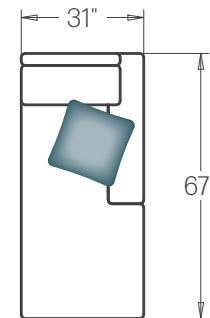

**Item #1210 EL
RAF Chaise**

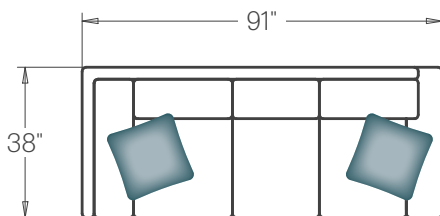

**Item #1212 EL
RAF Corner Sofa**

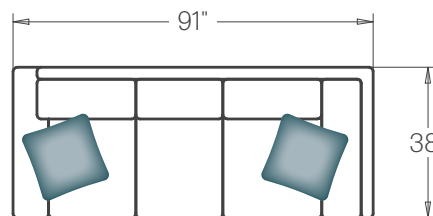

**Item #1213 EL
LAF Corner Sofa**

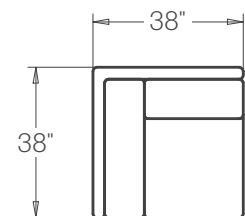

**Item #1214 EL
Corner Seat**

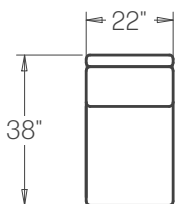

**Item #1215 EL
Armless Chair**

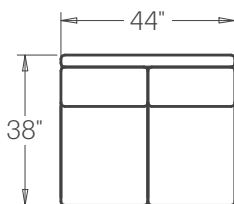

**Item #1216 EL
Armless Loveseat**

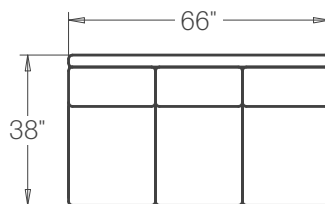

**Item #1217 EL
Armless Sofa**

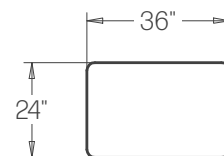

**Item #1136 EL
36" Footstool**

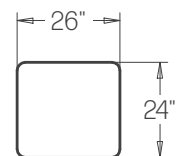

**Item #1126 EL
26" Footstool**

ELLINGTON 1200 SECTIONAL EXAMPLES

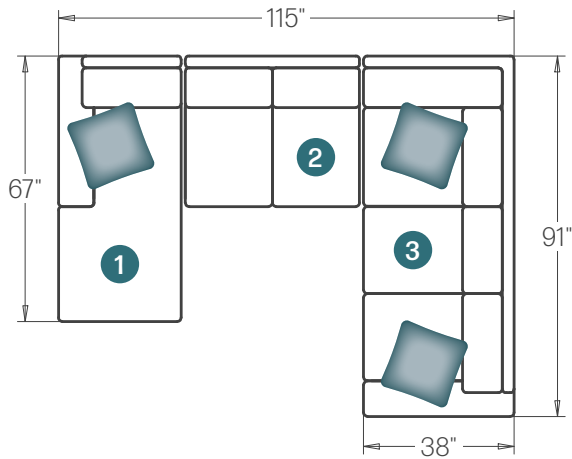

1 - Item #1211 EL LAF Chaise
 2 - Item #1216 EL Armless Loveseat
 3 - Item #1212 EL RAF Corner Sofa

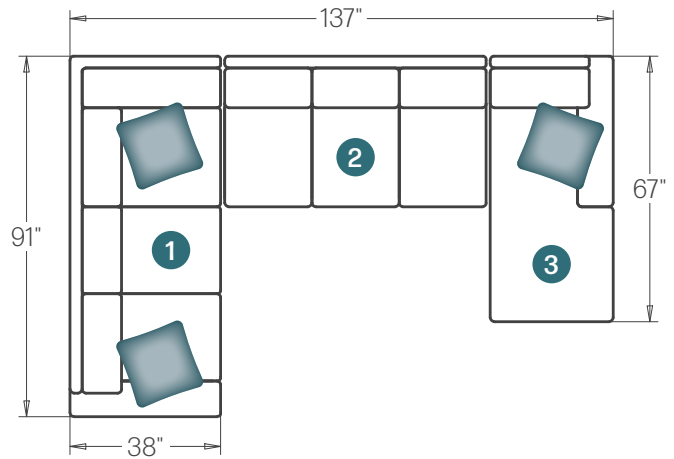

1 - Item #1213 EL LAF Corner Sofa
 2 - Item #1217 EL Armless Sofa
 3 - Item #1210 EL RAF Chaise

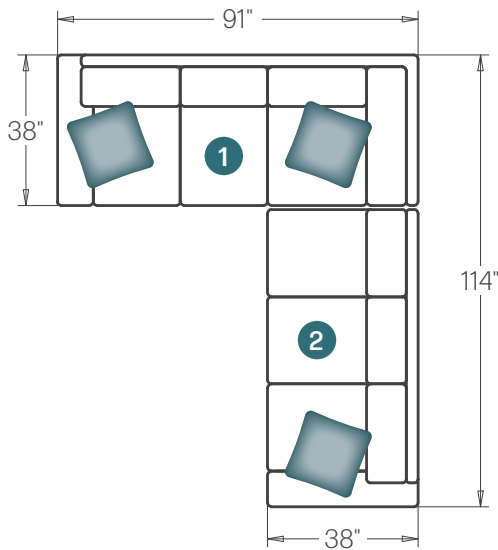

1 - Item #1213 EL LAF Corner Sofa
 2 - Item #1206 EL RAF Sofa

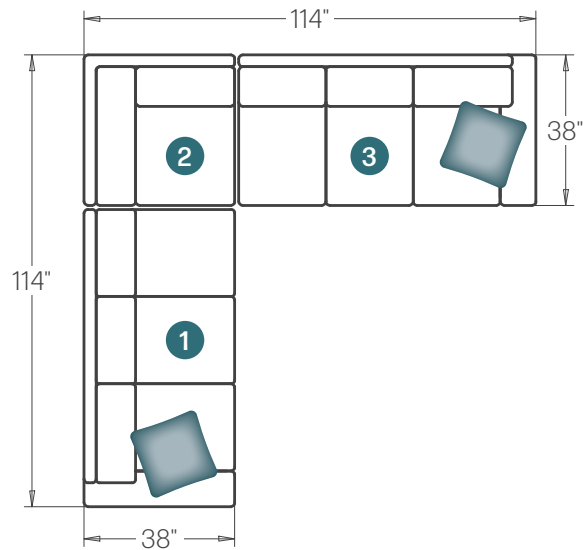

1 - Item #1209 EL LAF Sofa
 2 - Item #1214 EL Corner Seat
 3 - Item #1206 EL RAF Sofa

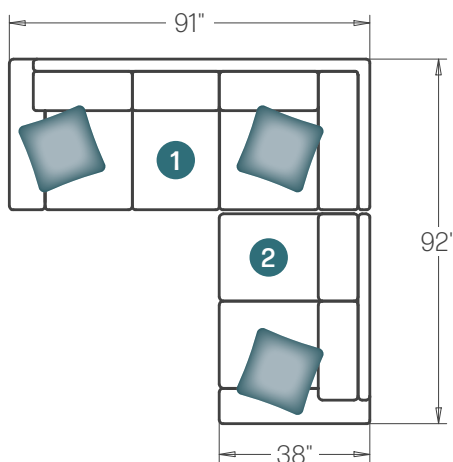

1 - Item #1213 EL LAF Corner Sofa
 2 - Item #1208 EL LAF Loveseat

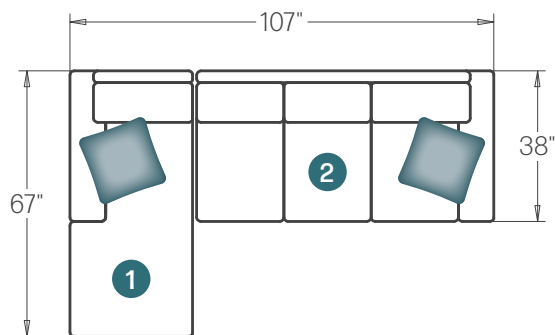

1 - Item #1211 EL LAF Chaise
 2 - Item #1206 EL RAF Sofa



LUXHOME
SEATING

HARMONY COLLECTION



FEATURES

- Drop-in Coil Spring System
- High Resilience 2.6 Density 30 Lb Seat Foam
- Removable Tapered Legs
- Foam Backs

POWER OPTION



Available on All Harmony Products Except for the Swivel Glider Recliner and Swivel Rocker Recliner

CUSTOM OPTIONS

- Softer 23 Lb Seat Foam (no upcharge)
- Firmer 40 Lb Seat Foam (no upcharge)

WOOD LEGS

- Available in Brown Maple or Oak
- See Page 36 for Stain Color Options

*Push Back Recliner Shown in R1-105 Black Fabric,
WH 5-Piece Sectional Shown in 7-83 Copper Fabric
and Brown Maple with FC 11047 Ebony*

HARMONY WH 6-PIECE SECTIONAL



Shown in 7-83 Copper Fabric and Brown Maple with FC 11047 Ebony

DIMENSIONS

	Length	Depth	Height	Inside Length	Seat Height	Seat Depth	Arm Height
31HY6PS Harmony WH 6-Piece Sectional	101 x 126	37	40 ½	63 x 88	19 ½	20	23 ½

WH = Wall Hugger

HARMONY WH 5-PIECE SECTIONAL



Shown in 7-83 Copper Fabric and Brown Maple with FC 11047 Ebony

DIMENSIONS

	Length	Depth	Height	Inside Length	Seat Height	Seat Depth	Arm Height
30 HY5PS Harmony WH 5-Piece Sectional	101 x 101	37	40 ½	63 x 63	19 ½	20	23 ½

HARMONY WH SOFA RECLINER



Shown in 7-83 Copper Fabric and Brown Maple with FC 11047 Ebony

DIMENSIONS

	Length	Depth	Height	Inside Length	Seat Height	Seat Depth	Arm Height
26 HYSR Harmony WH Sofa Recliner	85	37	40 ½	75	19 ½	20	23 ½

WH = Wall Hugger • Note: Both Ends of Sofa Recline, Middle is Stationary

HARMONY WH LOVESEAT RECLINER



Shown in 7-83 Copper Fabric and Brown Maple with FC 11047 Ebony

DIMENSIONS

	Length	Depth	Height	Inside Length	Seat Height	Seat Depth	Arm Height
25 HYL R Harmony WH Loveseat Recliner	60	37	40 ½	50	19 ½	20	23 ½

HARMONY WH RECLINER W/POWER OPTION



Shown in 7-83 Copper Fabric and Brown Maple with FC 11047 Ebony

DIMENSIONS

	Length	Depth	Height	Inside Length	Seat Height	Seat Depth	Arm Height
24 HYCR Harmony WH Recliner	35	37	40 ½	25	19 ½	20	23 ½

WH = Wall Hugger

HARMONY PUSH BACK RECLINER



Shown in R1-105 Black Fabric and Brown Maple with FC 11047 Ebony

DIMENSIONS

	Length	Depth	Height	Inside Length	Seat Height	Seat Depth	Arm Height
23 HYR Harmony Push Back Recliner	32	38	42 ½	22 ½	19	20	25

HARMONY ROCKER RECLINER



Shown in R1-105 Black Fabric

DIMENSIONS

	Length	Depth	Height	Inside Length	Seat Height	Seat Depth	Arm Height
21 HYRR Harmony Rocker Recliner	33	38	40 ½	23	19 ½	20	25

HARMONY SWIVEL GLIDER RECLINER



Shown in R1-105 Black Fabric

DIMENSIONS

	Length	Depth	Height	Inside Length	Seat Height	Seat Depth	Arm Height
20 HYGRS Harmony Swivel Glider Recliner	33	38	40 ½	23	19 ½	20	25

HARMONY SWIVEL ROCKER RECLINER



Shown in R1-105 Black Fabric

DIMENSIONS

	Length	Depth	Height	Inside Length	Seat Height	Seat Depth	Arm Height
22 HYRRS Harmony Swivel Rocker Recliner	33	38	41 ½	23	20 ½	20	26



LUXHOME
SEATING

SERENE COLLECTION



FEATURES

Drop-in Coil Spring System
High Resilience 2.6 Density 30 Lb Seat Foam
Removable Round Tapered Legs
Foam Backs

CUSTOM OPTIONS

Softer 23 Lb Seat Foam (no upcharge)
Firmer 40 Lb Seat Foam (no upcharge)

WOOD LEGS

Available in Brown Maple or Oak
See Page 36 for Stain Color Options

FULLY MODULAR

- Select Arm Style (FA Flat Arm or TDA Tear Drop Arm)
- Select Wood Leg Species
- Select Wood Leg Stain
- Select Extra Seat Unit if You Need Additional Seating Configuration

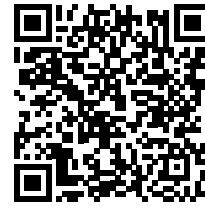

EDUCATIONAL
VIDEO



ASSEMBLY
MANUAL

Q&A

Q: The catalog says that I can't order any pattern match fabric, does that mean I can't order fabric with patterns on it?

A: You can order fabric that has patterns on it, but we won't be able to match the patterns from one seat to the next.

Q: How do I order a 4+ seat sofa?

A: Start with the 3-seat sofa and order the Serene extra seat unit for as many seats as you want to add.

Q: How do I order a 4-seat sectional instead of the listed 5-seat sectional?

A: Order the 4-seat sectional and deduct the price of a Serene extra seat unit to get the correct pricing.

Q: How do I order a 5+ seat sectional instead of the listed 5-seat sectional?

A: Start with the 5-seat sectional and order the Serene extra seat unit for as many seats as you want to add.

Q: How do I order a U sectional that gets more than 1 corner seat?

A: Please contact us for a quote.

Q: Will I get 1 less seat cushion for the sofa if I order a sofa and a chaise together since the chaise comes with 1 long cushion?

A: No, the chaise is an "add on option" so you will always get a complete set of whatever you order with the chaise, which will then allow you to add or remove the chaise whenever you need.

REVERSIBLE CUSHIONS



SERENE 5-SEAT SECTIONAL FLAT ARM



SERENE 5-SEAT SECTIONAL TEAR DROP ARM



Shown in C16-11 Astrid Fabric and Brown Maple with FC 11047 Ebony

DIMENSIONS

	Length	Depth	Height	Inside Length	Seat Height	Seat Depth	Arm Height
13 S5SS-FA Serene 5-Seat Sectional Flat Arm	88 - 88	34	32	71 - 71	17 ½	21	24
17 S5SS-TDA Serene 5-Seat Sect. Tear Drop Arm	88 - 88	34	32	71 - 71	17 ½	21	26 - 26

SERENE SOFA FLAT ARM



SERENE SOFA TEAR DROP ARM



Shown in C16-11 Astrid Fabric and Brown Maple with FC 11047 Ebony

DIMENSIONS

	Length	Depth	Height	Inside Length	Seat Height	Seat Depth	Arm Height
12 SS-FA Serene Sofa Flat Arm	85	34	32	75	17 ½	21	24
16 SS-TDA Serene Sofa Tear Drop Arm	82	34	32	75	17 ½	21	25 - 26

SERENE LOVESEAT FLAT ARM



SERENE LOVESEAT TEAR DROP ARM



Shown in C16-11 Astrid Fabric and Brown Maple with FC 11047 Ebony

DIMENSIONS

	Length	Depth	Height	Inside Length	Seat Height	Seat Depth	Arm Height
11 SL-FA Serene Loveseat Flat Arm	60	34	32	50	17 ½	21	24
15 SL-TDA Serene Loveseat Tear Drop Arm	60	34	32	50	17 ½	21	24 - 26

SERENE CHAIR FLAT ARM



SERENE CHAIR TEAR DROP ARM



Shown in C16-11 Astrid Fabric and Brown Maple with FC 11047 Ebony

DIMENSIONS

	Length	Depth	Height	Inside Length	Seat Height	Seat Depth	Arm Height
10 SC-FA Serene Chair Flat Arm	35	34	32	25	17 ½	21	24
14 SC-TDA Serene Chair Tear Drop Arm	35	34	32	25	17 ½	21	23 - 26

SERENE FOOTSTOOL



*Shown in C16-11 Astrid Fabric and
Brown Maple with FC 11047 Ebony*

DIMENSIONS

	Length	Depth	Height	Inside Length	Seat Height	Seat Depth	Arm Height
19 SF Serene Footstool	25	25	17	-	-	-	-

SERENE CHAISE



Shown in 7-83 Copper Fabric and Brown Maple with FC 11047 Ebony

DIMENSIONS

	Length	Depth	Height	Inside Length	Seat Height	Seat Depth	Arm Height
18 SCH Serene Chaise	25	25	17 ½	25	17 ½	46	-

SERENE EXTRA SEAT UNIT



Shown in C16-11 Astrid Fabric and Brown Maple with FC 11047 Ebony

DIMENSIONS

	Length	Depth	Height	Inside Length	Seat Height	Seat Depth	Arm Height
SESU Serene Extra Seat Unit	25	34	32	25	17 ½	21	-

SERENE AVAILABLE PIECES

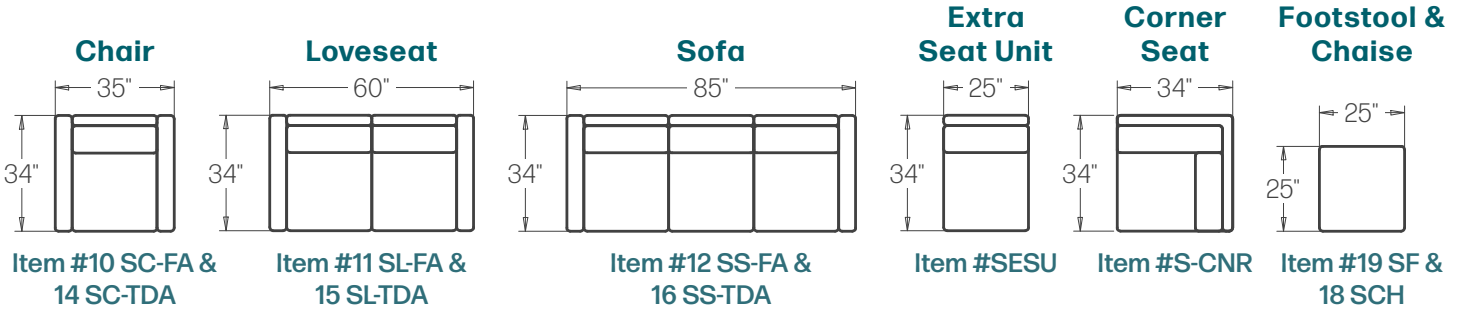

SECTIONAL SECTIONAL EXAMPLES

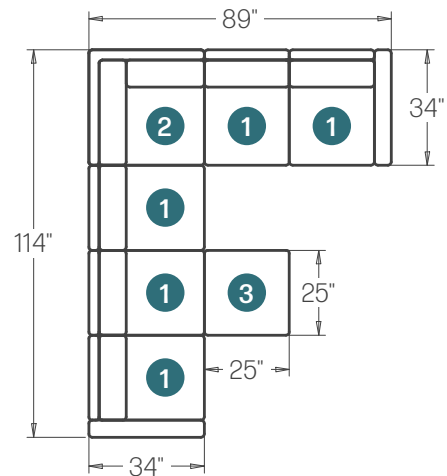
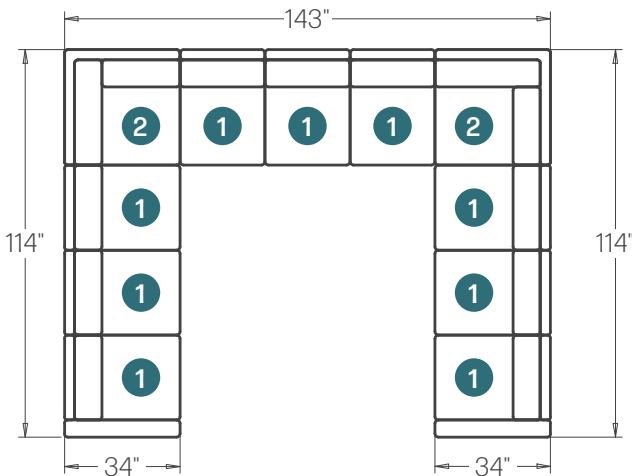
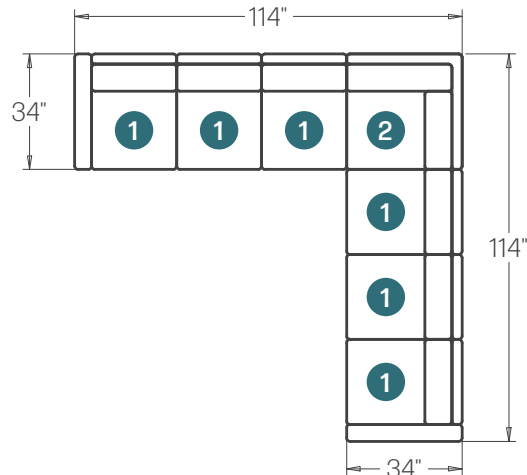
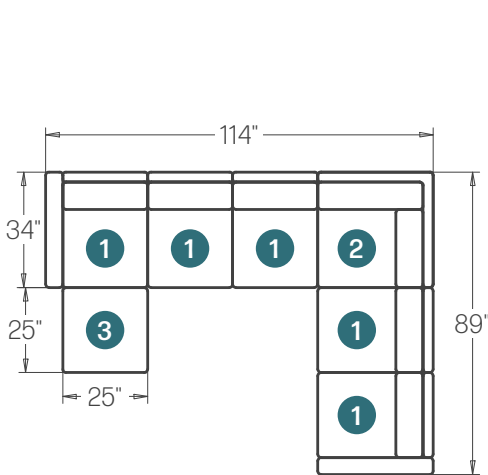

BROWN MAPLE STAIN COLORS



Natural



Almond (FC 42000)



Sealy (FC 44938)



Michael's Cherry



Driftwood (FC 11434)



Earthtone (FC 40592)



Acres (D22R00973)



Ebony (FC 11047)

OAK STAIN COLORS



Natural



Almond (FC 42000)



Sealy (FC 44938)



Michael's Cherry



Driftwood (FC 11434)



Earthtone (FC 40592)



Acres (D22R00973)



Ebony (FC 11047)

FABRICS & LEATHERS

Heartland Fabrics, LLC

**Wholesale Distributors of
Quality Fabrics, Leather & Suedes**

- Over 400 In-Stock Fabrics
- Genuine Full Hide Leathers
- Faux Leathers
- Micro Suedes
(Water Resistant)
- Crypton® Home Fabric
Easy Clean – Durable – Odor Resistant
- Revolution
Performance Fabric
Stain Resistant
- Indoor and Outdoor
Performance Fabric
Stain Resistant
- Full Rolls / Cut Yardage

Servicing furniture builders, upholstery shops, & buggy shops

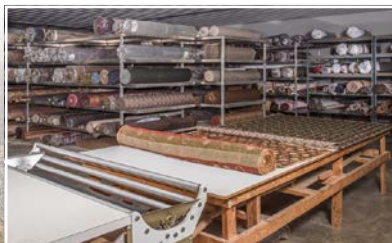

Conveniently located in Northern Indiana, call or write for more information. (Fax orders if possible.) Please include your business name and address.
5355W 400S • Topeka, IN 46571 • VM: (574) 642-1223 • Fax: (260) 593-4802

To view upholstery options visit heartland-fabrics.com

CARE & CLEANING GUIDE



Caring for fully upholstered furniture is essential to maintain its appearance and longevity.

GENERAL MAINTENANCE

- 1. Regular Vacuuming:** Dust mites, pet dander, and allergens accumulate over time. Vacuum your upholstered furniture at least once a month to remove surface dirt and debris. Use a clean, dry upholstery attachment or a stiff-bristle brush to loosen dried dirt and reach nooks and crannies.
- 2. Flip and rearrange loose cushions frequently:** This will help distribute the wear evenly.
- 3. Fluff throw pillows and loose or semi-attached backs frequently:** This will help them stay closer to their original shape.
- 4. Keep leather upholstery away from direct heat such as, fireplaces and air vents:** This can cause the leather to dry out and start cracking.
- 5. Avoid placing furniture in direct sunlight:** Place your upholstered furniture away from direct sunlight and heat sources. Sun exposure can fade fabrics, and excessive heat may damage them.

FABRIC CLEANING GUIDE

Standard Fabrics

Code WS: Spot clean with a mild solvent, an upholstery shampoo or the foam from a mild detergent.

Code S: Spot clean, using a mild water-free solvent or dry-cleaning product. Clean only in a well-ventilated room and avoid any product containing carbon tetrachloride or other toxic materials.

Code W: Spot clean, using the foam only from a water-based cleaning agent such as a mild detergent or non-solvent upholstery shampoo product. Apply foam with a soft brush in a circular motion. Vacuum when dry.

Performance Easy Clean Fabrics

Performance fabrics are easy to clean, but are not self-cleaning. Most spills will simply blot off the surface with a dry towel. And for more difficult stains, just follow these simple spot cleaning instructions

- Wipe away excess mess using a clean, dry towel
- Mix a simple soap and water solution*
- Apply and agitate with a soft bristle brush
- Blot with a clean towel
- Rinse thoroughly, and repeat if necessary

*We recommend mixing 1 tsp. enzyme laundry detergent, like Tide or Cheer, with 2 cups warm water. And remember, soap attracts dirt, so rinse thoroughly.

LEATHER CLEANING GUIDE

- Blot up spills immediately using a clean, white cloth
- Dust frequently with a soft, dry white cloth
- Clean regularly with a soft, white cloth that is lightly dampened with water. After wiping, gently rub with a soft dry cloth to remove soil.
- Never use polishes, oils, ammonia, cleaning fluids, solvents or detergents to clean. (The use of cleaning agents may cause damage and void the warranty.)

WARRANTY

Our consumer protection is our promise to you, the original purchaser, that each piece of LuxHome Seating products will be free from manufacturing defects for its useful life, provided the furniture is used in a residential application.

HARDWOOD FRAMES AND SPRINGS

LuxHome Seating warrants to you, the original retail purchaser, lifetime protection against manufacturing defects of frames and springs.

SEAT FOAM CORES

We fabricate our standard seating with (High Resilient 2.6 Density) polyurethane foam, which is considered the highest quality foam available to the upholstered furniture industry. LuxHome Seating warrants you the original retail purchaser, a lifetime warranty on our high resilient foam cores against any manufacturing defects for the lifetime of the product. The seat foam core refers only to the foam of the cushion, not the fiber wrap or the fabric or leather casing.

Note: Even though we use a high performing polyurethane foam, some flattening or loss of resiliency will occur as a result of normal use and aging. This is not covered under the warranty.

Cushion materials conform to the shape of the user and is not considered to be a manufacturing defect.

Cushion softness is significantly affected by the type of fabric or leather that surrounds it. Proper maintenance and seat cushion rotation where applicable will provide longer life and greater durability.

Cushions suspected to be defective must be returned to the builder for industry testing. If it is determined that the cores were not properly cared for or were under extreme abuse, would void the warranty. If found defective, LuxHome Seating will replace at no charge. Shipping and handling charges will apply to cushion cores replaced after two (2) years.

Blown Fiber Backs Note: Back cushions with blown fiber filling are exceptionally soft, but these fibers will show a loss of resilience as a result of normal use. LuxHome Seating cannot warrant blown-fiber back cushions against softening and flattening of fibers, which are considered normal wear, and not defects. The cushions should be fluffed occasionally to keep these fibers evenly distributed.

RECLINER MECHANISMS: (250LB LOAD RATING)

LuxHome Seating warrants to you the original purchaser, a limited three (3) year warranty for residential use only. In the event a mechanism is determined by LuxHome Seating to be defective within the warranty period, LuxHome Seating will, at its option, repair or replace the mechanism.

In no event shall LuxHome Seating be responsible for any disassembly, installation, or labor charges outside of our manufacturing facility. In addition, LuxHome Seating shall not be responsible for any shipping or packaging charges, except during the first year of this warranty.

FABRIC

LuxHome Seating warrants all fabrics for a period of one year to the extent of the warranty provided to LuxHome Seating by the original fabric supplier. In general, fabric manufacturers do not warrant for pilling, shading, fading, shrinkage, wrinkling, or stretching, so those properties are not covered under this warranty.

LEATHER

LuxHome Seating warrants all leathers for a period of one year to the extent of the warranty provided to LuxHome Seating by the original leather supplier. In general, leather manufacturers do not warrant for improper cleaning or contact damage, fading, shrinkage, wrinkling, or stretching, so those properties are not covered under this warranty. Leather is a natural product, so wrinkles, insect bites, healed scars and other natural markings, as well as some color and surface variations, are not considered flaws.

Exclusions: This warranty does not apply to furniture that is intentionally misused, or to damage resulting from negligence, exposure to sunlight or outdoor elements, nonresidential use, improper cleaning, pet damage, or other unreasonable use, or to fabric damage or failure due to a fabric protection chemical treatment, improper cleaning, or when abnormal heavy soiling or abuse is evident. This warranty applies only to the original purchaser and terminates in the event of resale or recover. Because LuxHome Seating is made by hand using natural materials, minor variations will occur from piece to piece. Therefore, this warranty does not cover such minor differences between your furniture and in-store samples, printed materials, and video or Internet displays.



LUXHOME
SEATING